

An H frame for 4 x 8el 144MHz LFA Yagis

Description

A 2.4m x 2.2m H frame for use with the 8el 144MHz LFA Yagi

Should you be looking to work via the moon (EME) or just work some serious DX via MS (meteor scatter) or just pack a punch! The InnovAntennas H shaped stacking frame allows you to do just that. Combining the power of 4 antennas in one setup carries with it a lot of benefits including the performance of a much bigger single Yagi within a relatively small package.

Our H frame is designed to allow most common Elevation rotator fitments (such as Yaesu G5500 of SPID) although **we can custom-make any H frame to suit your particular rotor requirements**. All our H frames use square box section tubing which ensures easy **alignment and setup during install** and also ensures over time your antennas **will not twist** and point in different directions.

All supplied hardware is Marine grade stainless steel and the H frame is supplied with 4 specifically designed boom to mast brackets to suit your antennas boom.

Specification highlights

1. **Marine grade Stainless Steel Fittings***
2. **4 x Specifically designed boom to mast brackets**
3. **Mill finished for highest levels of accuracy**
4. **Simple and easy construction**
5. **Stack Frame size 2.4m V x 2.2m H**

Notes on the designs of our H frames

The standard supplied sizes for our H frames will ensure the lowest noise and most quiet patterns with absolute minimum side lobes. These stacking positions do alter from those specified on our specific antenna page on our site. However, the sizes presented on the individual antenna pages reflect DL6WU calculated spacing (with minor adjustments) which represented industry standards and allows for easy comparison. Our frames are arranged to allow our antennas to perform in the way they were designed. If you require this or any other wider/larger spacing, we will be happy to discuss your requirement with you and provide a solution that suits you.

Should any customer require another configuration, we will provide the H frame to suit.

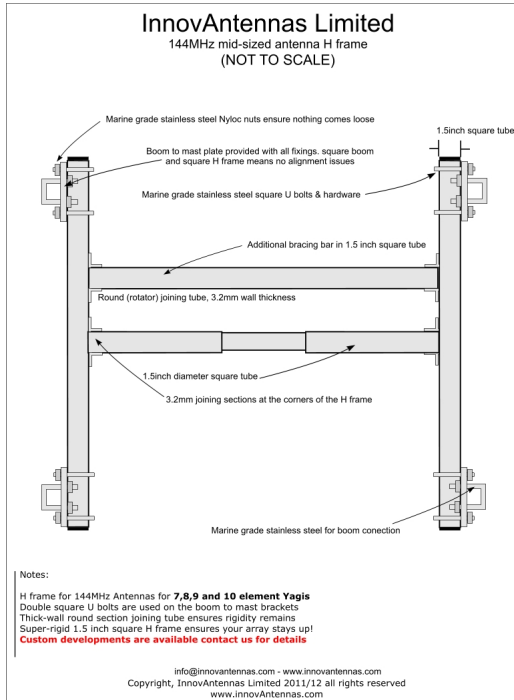

Manufactured the right way, not the cheapest way!

*Where possible marine grade stainless steel components are used.

//