

Sales price £299.95

Sales price without tax £249.96

Tax amount £49.99

A Dual band 70/144MHz Yagi with single feed point 18 element in total and 4.5m boom



Description

An Excellent 18 element Dual Band Yagi for 70/144MHz on a 4.9m boom and single feed point

The 4-2-18 Dual Band Yagi has a total of 18 elements, 7 elements are used on 70MHz while 11 elements are used on 144MHz. The 4-2-18 InnovAntennas Dual Band Yagi stands aside from the crowd due to the methods used for it's design. The 4-2-18 does not use traps or coils, no phasing arrangements and has no need for 'compromise' spacing between elements as the antenna has a set of correctly spaced elements for either band but still deploys only one feed point. An excellent antenna with great SWR bandwidth and performance in one package.

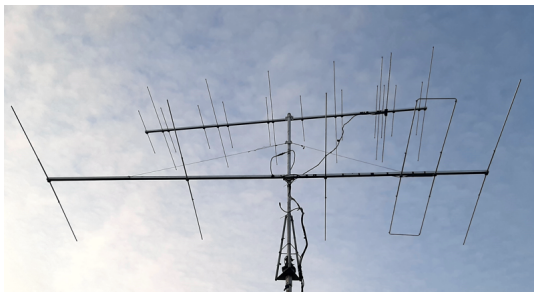

Top - G0GGG installs the 18el 4m/2m above an InnovAntennas 50MHZ LFA-3 and reports as below:

"SWR 1:1 on 4m, 1:1.1 - 1:1.2 on 2m @ FT8

"I'll send another picture with 6m 6ele LFA3 when swapped out"

Performance

Gain on 70MHz: 11.00dBi @ 70.20MHz

F/B on 70MHz: 19.48dB @ 70.20MHz

Gain on 70MHz at 10m above Ground: 16.66dBi

Gain on 144MHz: 13.61dBi @ 144.300MHz

F/B on 144MHz: 20.29dB @ 144.300MHz

Gain on 144MHz at 10m above Ground: 19.45dBi

Power Rating: 3kw+

SWR 50MHz: Below 1:1.4 from 70.00MHz to 70.400MHz

SWR 70MHz: Below 1:1.5 from 144MHz to 144.800MHz

Boom Length: 4.5m

Weight: 11Kg

Turning Radius: 2.55m

Wind Loading: 0.27 Square Metres

Wind Survival: 160KPH / 100MPH

Specification

This antenna is made with (10mm). The antenna has fully insulated elements which will ensure continuous, high performance for many years to come. Boom to mast brackets are included with all antennas which will support 2 inch (50mm) masts. **Boom is 40mm square aluminum with 2mm wall thickness.**

Our antennas are constructed with the best quality materials in order that the best mechanical construction can be achieved, not the cheapest and most profitable! Even a digital caliper is used (with an accuracy of .01mm) to measure the elements during production to ensure they are within 0.2mm of what they should be, ensuring they work as well as our software model predicts.

Note: Much development time has gone into our antennas, not just on basic electromagnetic design, we are able to model the effect of insulators, booms and other objects to ensure the make up of our antennas have least effect on performance and pattern degradation. More information can be found [here](#)

- Marine grade Stainless Steel Fittings
- Original Stauff Insulation clamps
- Mill finished boom and elements for highest levels of accuracy

Azimuth Plot 70MHz

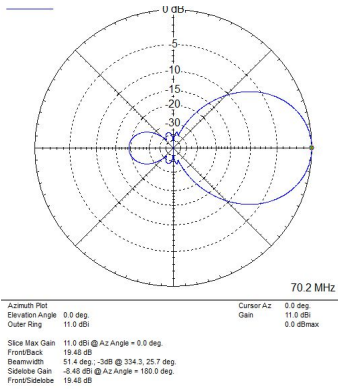

Elevation @ 10m above ground

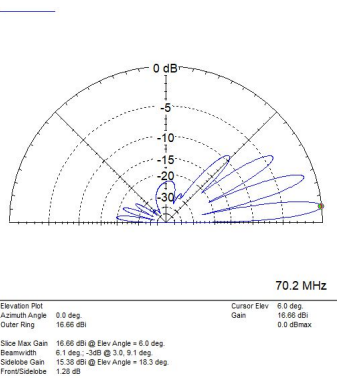

Azimuth Plot 144MHz

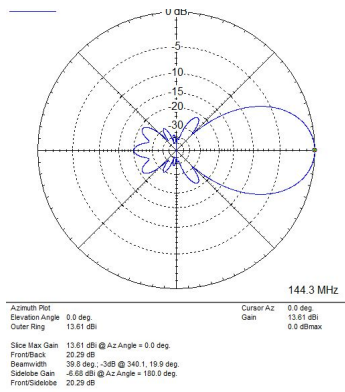

Elevation @ 10m above ground

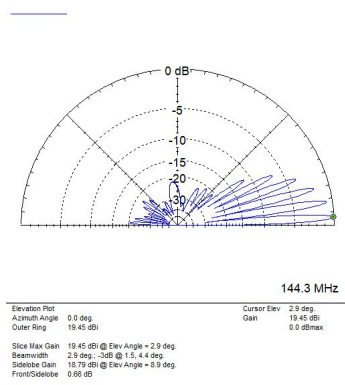

SWR 70MHz

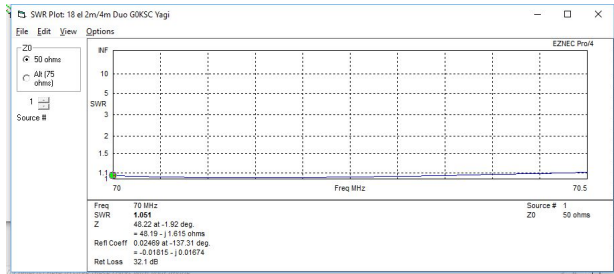

SWR 144MHz

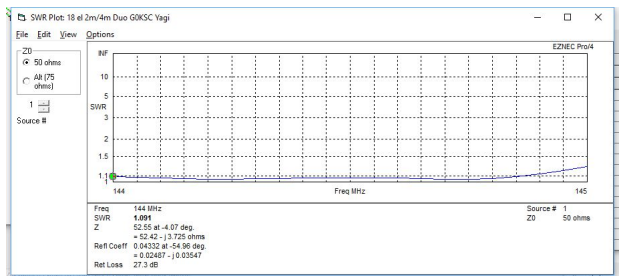

Manufactured the right way, not the cheapest way!

///